

Lucent Technologies
Bell Labs Innovations



**Integrated Services
Digital Network (ISDN)
8528T Voice Terminal
Feature Package 3
User's Manual**

555-021-776
Comcode 107964488
Issue 2
December 1996

WARRANTY

All terms and conditions specified in the owner's agreement with Lucent Technologies apply.

NOTICE

While reasonable efforts were made to ensure that the information in this document was complete and accurate at the time of printing, Lucent Technologies can assume no responsibility for any errors. Changes or corrections to the information contained in this document may be incorporated into future issues.

TO ORDER COPIES OF THIS DOCUMENT

Write: Lucent Technologies BCS Publications Center
P.O. Box 4100
Crawfordsville, IN 47933

Call: Voice 1 800 457-1235
International Voice 317 361-5353

Fax: Fax 1 800 457-1764
International Fax 317 361-5355

Order: Document No. 555-021-776
Issue 2, December 1996

DISCLAIMER

Intellectual property related to this product (including trademarks) and registered to AT&T Corporation has been transferred to Lucent Technologies Incorporated. Any references within this text to American Telephone and Telegraph Corporation or AT&T should be interpreted as references to Lucent Technologies Incorporated. The exception is cross-references to books published prior to December 31, 1996, which retain their original AT&T titles.

HERITAGE

Lucent Technologies — formed as a result of AT&T's planned restructuring — designs, builds, and delivers a wide range of public and private networks, communication systems and software, consumer and business telephone systems, and microelectronics components. The world-renowned Bell Laboratories is the research and development arm for the company.

THE "CE" MARK

The "CE" mark affixed to this equipment means that it conforms to the European Union Electromagnetic Compatibility Directive (89/336/EEC) and the Low Voltage Directive (73/23/EEC).

HEARING AID COMPATIBILITY

These voice terminals are Hearing Aid Compatible ("HAC"). In addition, some units have an "HAC" label on them.

TRADEMARKS

DEFINITY and 5ESS are registered trademarks of Lucent Technologies.

Prepared by
BCS Product Documentation Development
Middletown, NJ 07748-9972

© 1996 Lucent Technologies
All Rights Reserved
Printed in USA

INTERFERENCE WARNING INFORMATION - Part 15 of FCC Rules

Federal Communications Commission (FCC) Rules require that you be notified of the following:

This equipment has been tested and found to comply with the limits for a Class A digital device, pursuant to Part 15 of the FCC Rules. These limits are designed to provide reasonable protection against harmful interference in a residential installation. This equipment generates, uses and can radiate radio frequency energy and, if not installed and used in accordance with the instructions, may cause harmful interference to radio communications. However, there is no guarantee that interference will not occur in a particular installation. If this equipment does cause interference to radio or television reception, which can be determined by turning the equipment off and on, the user is encouraged to try to correct the interference by one or more of the following measures:

- Reorient or relocate the receiving antenna.
- Increase the separation between the equipment and receiver.
- Connect the equipment into an outlet on a circuit different from that to which the receiver is connected.
- Consult the dealer or an experienced radio/TV technician for help.

You may find the following booklet prepared by the Federal Communications Commission helpful: *How to Identify and Resolve Radio-TV Interference Problems*. This booklet is available from the U.S. Government Printing Office, Washington, D.C. 20042, Stock No. 004-000-00345-4.

IMPORTANT SAFETY INSTRUCTIONS

Only the most careful attention has been devoted to quality standards in the manufacture of your new telephone. Safety is a major factor in the design of every set. But, safety is YOUR responsibility too.

Please read carefully the helpful tips listed below and on the next page. These suggestions will enable you to take fullest advantage of your new voice terminal. Then, retain these tips for later use.

When using your telephone equipment, the following safety precautions should always be followed to reduce the risk of fire, electric shock, and injury to persons.

- Read and understand all instructions.
- Follow all warnings and instructions marked on the telephone.
- This telephone can be hazardous if immersed in water. To avoid the possibility of electrical shock, do not use the telephone while you are in the bathtub or shower, or when you are wet. If you accidentally drop the telephone into water, do not retrieve the equipment until you have first unplugged the line cord from the modular wall jack. Do not reconnect the telephone until it has dried thoroughly.
- Avoid using the telephone (other than the cordless type) during electrical storms in your immediate area. There is a remote risk of electric shock from lightning. Urgent calls should be brief. Even though protective measures may have been installed to limit electrical surges from entering your home or business, absolute protection from lightning is impossible.
- If you suspect a natural gas leak in the vicinity of the telephone, report it immediately, but use a telephone away from the area in question. The telephone's electrical contacts could generate a tiny spark. While unlikely, it is possible that this spark could ignite heavy concentrations of gas.
- Never push objects of any kind into the telephone through housing slots since they may touch hazardous voltage points or short out parts that could result in a risk of electric shock. Never spill liquid of any kind on the telephone. If liquid is spilled, however, dry immediately, and refer any service problems to qualified service personnel.
- To reduce the risk of electric shock, do not disassemble the telephone. There are no user serviceable parts inside. Opening or removing covers may expose you to hazardous voltages. Incorrect reassembly can cause electric shock when the telephone is subsequently used.

- Slots and openings in the housing must not be blocked or covered. The openings should never be blocked by placing the telephone on a sofa, rug or other similar surface. This product should never be placed near or over a radiator or heat register. This product should not be placed in a built-in installation unless proper ventilation is provided.
- The telephone should be operated only from the type of power source indicated on the marking label. If you are not sure of the type of power supply being used, contact a qualified service person.
- Do not allow anything to rest on the power cord. Do not locate this product where the cord will be abused by persons walking on it.
- Do not overload the AC wall outlets and extension cords as this can result in risk of fire or electric shock.
- Before cleaning, disconnect all cords from the telephone. Do not use liquid cleaners or aerosol cleaners. Use a damp cloth for cleaning.
- Disconnect the cords on the telephone and refer servicing to qualified service personnel when these conditions exist:
 - ▶ When the power supply cord or plug is damaged or frayed.
 - ▶ If liquid has been spilled into the product.
 - ▶ If the product has been exposed to rain or water.
 - ▶ If the telephone does not operate normally by following the operating instructions. Do not attempt to adjust any other controls since doing so may result in damage and will require extensive work by a qualified technician to restore the product to normal operation.
 - ▶ If the product has been dropped or the housing has been damaged.
 - ▶ If the product exhibits a distinct change in performance.

SAVE THESE INSTRUCTIONS



When you see this warning symbol on the product, refer to the instructions booklet packed with the product for information before proceeding.

Contents

Introduction	1
Organization of this Manual	1
Conventions Used in this Manual	2
A Note on the Term, System Manager	3
Your ISDN 8528T Voice Terminal	4
Feature Descriptions	8
Voice Features.....	8
Features Accessed with the Display and Softkeys.....	9
Voice Features	11
Answering and Placing a Call	11
Conference.....	12
Drop.....	12
Hold.....	13
Message Retrieval	13
Mute	14
Redial (Last Number Dialed)	14
Speakerphone and One-Way Speaker	15
Transfer	17
Features Accessed with the Display and Softkeys	18
Entering and Exiting Softkey Mode (Using the Menu and the Exit Buttons)	19
Using the Next, the Prev, and the Dir Buttons	20
Responding to Quit and Done.....	20
A Softkey Display Screen Flowchart	20
Setting the Clock	22
Setting the Speakerphone	24
Adding, Editing, and Deleting a Number and Name in the Directory	26
Viewing a Directory Entry (and Placing a Call).....	33
Using the Dir Button to Place a Call	35

Using the Call Log.....	36
Locking and Unlocking the Directory, Call Log, and All Softkeys	54
Changing or Removing Your Password.....	58
Choosing the Contrast Level for the Display.....	60
Selecting a Personalized Ring.....	62
Setting the Rate at Which You View the Display Messages	64
Turning on or off Softkey Information Tones.....	66
Setting the Number of Names on the Directory Page	68
Self-Test	70
Tones and Their Meanings	72
Voice Terminal Tones	72
Labeling and Installing the Designation Card and the Telephone Number Card	72
Installation	74
Contents of the 8528T Package	74
Connecting the 8528T to the System.....	74
Desktop Installation	78
Attaching Adjunct Equipment	80
Technical Description	81

Introduction

The Lucent 8528T voice terminal can be added to your Integrated Services Digital Network (ISDN) communications system. In order to provide you with excellent quality and reliability, Lucent designed this new voice terminal with the latest advances in telecommunications technology.

The 8528T voice terminal offers 28 call appearances, Mute, Redial, Conference, Drop, Transfer, and Hold buttons, a Speakerphone which can also be optioned as a listen-only Speaker, a Volume control, and an Adjunct jack for adjunct equipment such as a headset adapter — all that you will need for easy and efficient call-handling. Four softkeys (the keys with arrows printed on them) and four display control buttons located below a 2-line by 24-character liquid crystal display can be used to access such features as a personal Directory, a Call Log which lists the most recent incoming and outgoing calls, and a personalized ringing pattern for the voice terminal.

The following features have been included for the hearing and visually impaired person:



- Two small bars have been placed on the **5** dial pad key;
- The rate at which the display messages appear on your screen can be set at **Slow**, **Medium**, or **Fast**;
- Confirmation and error tones;
- Compatibility with inductively coupled hearing aids.

ORGANIZATION OF THIS MANUAL

This manual is arranged into the following sections:

- **Your ISDN 8528T Voice Terminal** — shows the top and bottom views of the 8528T and explains its features.
- **Feature Descriptions** — lists the voice features and the features that can be accessed with the softkeys, tells what each feature does, and suggests how you might use it.
- **Voice Features** — gives step-by-step procedures on using voice features.

- **Features Accessed with the Display and Softkeys** — describes the softkeys and how to use them to access features such as setting up and using a personal Directory of frequently called numbers and viewing a Call Log of incoming and outgoing calls.
- **Tones and Their Meaning** — lists and describes the various voice terminal tones.
- **Labeling and Installing the Designation Card** — explains how to remove and label the designation card.
- **Installation** — gives brief step-by-step procedures for connecting your voice terminal to the system, desktop installation such as connecting the handset and the line cord, and, if appropriate, attaching adjunct equipment.
- **Technical Description** — provides information on the technical aspects of the 8528T voice terminal.

CONVENTIONS USED IN THIS MANUAL

A **rectangular box** containing a feature name, such as Redial, represents any button having a feature assigned to it, with a corresponding feature name label.

A **2-line screen**, such as

MENU	>
Directory CallLog Option	

represents the display that is shown when you press the Menu display control button. The second line of the display lists the features you can access by using the four softkeys (the buttons labeled with arrows).

A NOTE ON THE TERM, "SYSTEM MANAGER"

In this manual it is often suggested that you refer to your **System Manager** for more information. The System Manager may also be called the *System Administrator* or, possibly, the *Telecommunications Manager*. For handy reference, use the space below to write your System Manager's name, room number, and extension.

Name _____

Room _____ Extension _____

Your ISDN 8528T Voice Terminal

Before you begin using your ISDN 8528T voice terminal, familiarize yourself with the voice terminal features, lights, jacks, and other components that are available to you. To help you do this, **Figure 1** below and **Figure 2**, which appears later in this section, show you the top and bottom views of the 8528T voice terminal.

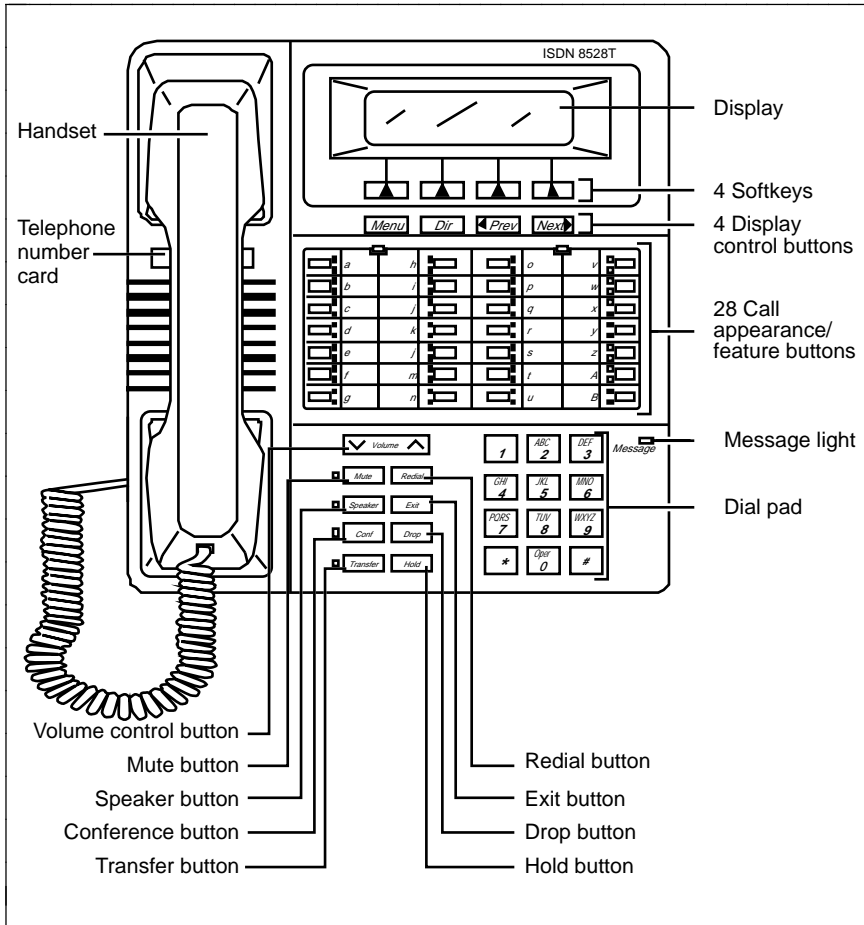

FIGURE 1 8528T Voice Terminal (Top View)

The 8528T voice terminal components pictured in **Figure 1**, the top view, are described below and on the next page. For your convenience, they are listed alphabetically.

Call appearance/feature buttons These 28 buttons are devoted *either* to handling incoming and outgoing calls (call appearances) and are labeled with the telephone number or extension *or* they can be used as feature buttons to access voice features such as Call Forward or Send All Calls; these are labeled with the feature name. Each of these 28 call appearance/feature buttons has a red light, which indicates the *selected line* and a green light which indicates the *status of that line or feature*.

NOTE: These buttons are arranged in four columns. The first column is labeled **a** through **g**; the second column is labeled **h** through **n**; the third column is labeled **o** through **u**; the last column is labeled **v** through **z** and **A** and **B**.

Conference button For setting up conference calls with an additional party. Conference calls include you and two other parties.

Designation card For noting the call appearance telephone number or extension or feature that the button can access.

Dial pad The standard 12-button pad for dialing telephone numbers and accessing features. The letters, “Q” and “Z,” have been added to the **7** and **9** dial pad keys for entering Directory names, and the **5** button on your dial pad has raised bars for visually-impaired users.

Display control buttons These four buttons are labeled **Menu** , **Dir** , **◀ Prev** , and **Next ▶** .

- The **Menu** button is used to access the main softkey menu.
- The **Dir** (Directory) button allows you to quickly access Directory entries in order to place a call.
- The **◀ Prev** and **Next ▶** buttons can be used to help you go back and forth through menu options, to search for an entry in your Directory, and to view entries in your Call Log.

Drop button For disconnecting from a call or dropping the last party added to a conference call.

Exit button For exiting a display feature and returning to normal call-handling mode.

Handset For placing and answering calls (often people call it the receiver.)

Hold button A red button, for putting a voice call on hold.

Message light A red light which goes on steadily when a message has been left for you. See your System Manager for instructions regarding your local message retrieval procedures.

Mute button For turning off (and then back on again) the microphone of the handset or the speakerphone so the other person on the call cannot hear you.

Redial button For automatically redialing the last number that you dialed from the dial pad.

Softkeys The four buttons located below the display and labeled with arrows (), correspond to words on the display screen. Softkeys are used along with display control keys to access or create a personal Directory of frequently-called numbers, a Call Log of the most recent incoming and outgoing calls, and such features as selecting a personalized ringing pattern, doing a self-test of your voice terminal, and setting the speakerphone and the clock.

Speaker button For turning on and off the speakerphone or the listen-only speaker.

Telephone number card For noting the area code and telephone number of your voice terminal.

Transfer button For transferring a call to another voice terminal.

Volume control button When on a call, used to increase or decrease the receive volume of the handset or speakerphone. When you are not on a call, the Volume control button is used to increase or decrease the volume of the ringer and the tones.

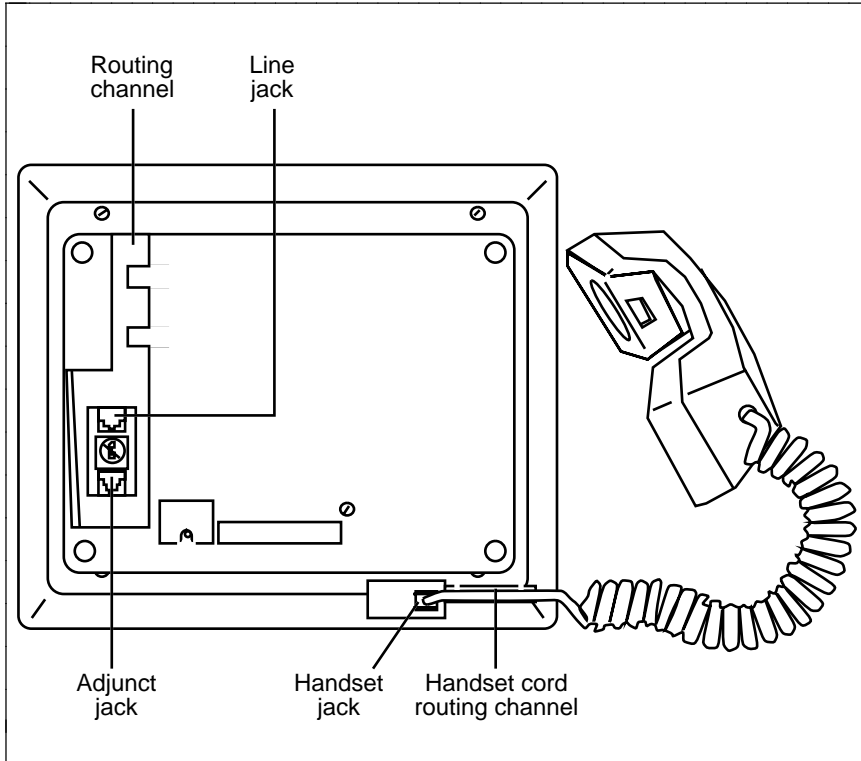



FIGURE 2 8528T Voice Terminal (Bottom View)

The various components which appear on the bottom of the 8528T voice terminal are shown in **Figure 2** and listed and explained below.

Adjunct jack Used for connecting an external speakerphone, a headset adaptor, or other adjunct equipment. The jack is labeled "ADJUNCT."

WARNING: Do **not** insert the handset cord into the "ADJUNCT" jack. It will cause equipment damage.

Handset jack Used for connecting the handset cord to your voice terminal. The jack is labeled  .

Line jack Used for connecting the line cord to your voice terminal. The jack is labeled "LINE."

Routing channels Thread the line cord and handset cord (and adjunct cord, if applicable) through the appropriate routing channel. See the section titled **Installation**. Be sure that you plug each cord into the correct jack.

Feature Descriptions

Here are brief descriptions of the voice features and the features accessed with the softkeys, including what each one does and how you might want to use it.

VOICE FEATURES

Conference Allows you to add an additional party to a call so that you can conduct a conversation with more than one party. Use to set up time-saving conferences, or to spontaneously include a party important to a discussion.

Drop Disconnects you from a call without requiring you to hang up the handset or press the switchhook. Use this feature whenever you wish to get dial tone to place another call without having to hang up. Can also be used with the Conference feature to disconnect the last party added.

Hold Temporarily disconnects you from a call, holding it until you can return to it. While a call is on hold, you can place another call, activate another feature, answer a waiting call, or leave your voice terminal to perform another task. Use when you have a call that you don't wish to drop, but for which you have to interrupt briefly to do something else.

Message Retrieval Your Message light goes on to let you know that a caller has left a message. Follow your System's message retrieval procedures to get your message.

Mute Turns off the microphone associated with the handset or the speakerphone, whichever is currently active. Use when you want to confer with someone in the room with you, but you do not want the other party on the call to hear your conversation. (You are still able to hear the person on the call.)

Redial (Last Number Dialed) Automatically redials the last number you dialed manually from the dial pad, either an extension or an outside number. Use to save time in redialing a busy or unanswered number.

Speakerphone Your voice terminal has either the Speaker (listen-only) or the Speakerphone (listen and talk) function or it may have neither. Check with the System Manager to see how your voice terminal is set.

The **One-Way Speaker** feature allows you to place calls or access other voice features without lifting the handset. (Press **Speaker** .) However, in order to speak to the other party, you must use the handset (the speaker will turn off). Use with feature activities that require *listening only*, such as dialing or monitoring calls when you have been placed on hold.

The **Speakerphone** feature allows you to place and answer calls or access other voice features without lifting the handset. (Press **Speaker** .) You may use the softkeys on the voice terminal to set or reset the speakerphone. When you set the built-in speakerphone, it performs a test of the surrounding environment and adjusts itself for optimal performance. (See the description of “Reset Speakerphone” later in this section.) Use the built-in speakerphone any time you prefer hands-free communications, both speaking and listening, or for group conference situations.

Transfer Transfers a call from your voice terminal to another extension. Use when your caller needs to speak further with someone else.

FEATURES ACCESSED WITH THE DISPLAY AND SOFTKEYS

The following features can be accessed using the four softkeys located below the display.

Call Log The Call Log is initially set to list the 10 most recent incoming unanswered calls only. An option is provided so that you may also choose to access the 10 most recent answered calls, and the 10 most recent outgoing calls placed from your voice terminal. Use to check on calls that you missed (the unanswered calls) and to remind you of those calls that you answered or placed most recently. You may also activate the feature which allows you to automatically call back callers from the incoming Call Log or automatically add those callers to your personal Directory.

Clock For setting the date and time on your voice terminal display.

Contrast Change the contrast level of your display so that the letters or numbers are darker or lighter against the background of the screen.

Directory Used to create and edit a personal Directory of up to 30 extensions or outside numbers and the names of the associated party. Use **Dir** to quickly dial a call. Use as a handy place to store numbers you frequently call.

Dir Button When you press **Dir** followed by a softkey button associated with a specific Directory entry, a call is immediately placed to the telephone number associated with that Directory entry. The phone number appears on the display screen as it dials.

Exit button Exits a display feature and returns the voice terminal display to normal call-handling mode.

Lock Allows you to lock your Directory so that no one can make unauthorized changes in it; lock your Call Log so that no one else can view your Call Log entries; lock all of the softkeys so that no one can view or change any of the features accessed by the softkeys.

Number of Names (on a Directory Page) Allows you to view *either* four names *or* three names + **Quit** on the second line of an individual Directory page. If you choose to have four names on the Directory screen at one time, you can leave the Directory or cancel calling a name in your Directory only by pressing **Exit** (rather than using the softkey **Quit**).

Personalized Ring Allows you to select your own personalized ringing pattern from among eight available patterns. Use to distinguish your voice terminal's ring from that of other nearby voice terminals.

Screen Timing (Rate at which the Display Message is Shown) Allows you to set the length of time the display message remains on the screen. There are three rates: Slow, Medium, and Fast.

Self-Test Performs a diagnostic test of your voice terminal including the lights, ringer, dial pad keys, and display.

NOTE: When you perform a self-test of the voice terminal, it clears the contents of the Call Log and the last number dialed from Redial, and returns the volume control to the default setting.

Set Speakerphone When you set the built-in speakerphone, it performs a test of the surrounding environment and adjusts itself for optimal performance.

Tones A confirmation tone (sequential low and high tones) is provided to let you know a selection has been accepted; an error tone (one beep) alerts you that you made a mistake in your softkey entries. You may choose to turn these softkey information tones on or off.

Voice Features

The procedures which follow give short, step-by-step instructions for using each feature. For your convenience, the features are listed alphabetically. Unless otherwise noted, the calling procedure assumes that the handset is off-hook.

ANSWERING AND PLACING A CALL

To answer a call

- 1 Lift the handset.
 - The green light (below the red light) goes on steadily at the selected call appearance button.

NOTE: If you are not connected immediately, press the call appearance button next to the flashing green light.

To place a call



- 1 Lift the handset, or press  .
 - The green (below the red light) goes on steadily at the selected call appearance button.
- 2 Listen for the dial tone and dial the number you want to call.

To end (or drop) a call

- 1 Hang up the handset or press  .

NOTE: If you use  , you will hear a dial tone and your voice terminal is ready for another call.

To adjust the receive volume of the handset, the speakerphone, or the listen-only speaker

- 1 While on a call,
 - to raise the volume, press the right half of the Volume control button labeled  ;
 - to lower the volume, press the left half of the Volume control button labeled  .

CONFERENCE

To add another party to a call

- 1 While on a call, press **Conf** to add the next party.
 - The current call is placed on hold.
 - The red Conference light flutters.
NOTE: If an idle call appearance button is not automatically selected, press one yourself.
- 2 Listen for the dial tone, and dial the number of the next party.
- 3 Press **Conf** after the next party answers.
 - The red Conference light goes off.
 - All parties are now connected.

To drop a party from a conference call

- 1 Press **Drop**.
 - The last party you added is dropped.

DROP

To disconnect from a 2-person call and obtain dial tone without hanging up

- 1 Press **Drop**.
 - Listen for dial tone.
NOTE: Pressing **Drop** will also disconnect the last party added to a conference call. See the procedures for the Conference feature in this section.

HOLD

To put a call on hold while you answer another call

NOTE: The green light is flashing beside the call appearance button of the incoming call.

- 1 Press **Hold** .
 - The red light goes off, and the green light flutters (next to the call appearance button of the held call).
- 2 Press the call appearance button of the second call.
 - The red light goes on, and the green light goes on steadily.
 - You are connected to the second call.

NOTE: If you put a conference call on hold, the other parties remain connected.

To return to the held call

- 1 Press the call appearance button next to the held call.
 - The red light goes on, and the green light goes on steadily (next to the call appearance button of the previously held call).
 - You are connected to the held call.

MESSAGE RETRIEVAL

See your System Manager for instructions regarding the message retrieval procedures for your system.

MUTE

To turn off the microphone associated with the handset or the speakerphone so the other party cannot hear you

- 1 While on a call, press **Mute** .
 - The red Mute light goes on.
 - The other party cannot hear your conversation, but you can hear the other party.

To turn on the microphone associated with the handset or speakerphone again, so the other party can hear you again

- 1 Press **Mute** again.
 - The red Mute light goes off.
 - You can resume your conversation with the other party.

REDIAL (LAST NUMBER DIALED)

To automatically redial the last number you dialed manually (this can be an extension, outside number, or trunk/feature code)

NOTE: The 8528T voice terminal redials a number consisting of up to 37 digits.

- 1 Lift the handset.
- 2 Listen for the dial tone, and press **Redial** .
 - The last number you dialed (from the dial pad) is automatically redialed.
- 3 Wait for the called party to answer.

SPEAKERPHONE AND ONE-WAY SPEAKER

NOTE: Your voice terminal is set for the One-Way Speaker (listen-only) *or* for the Speakerphone (listen and speak) function *or* for neither. Check with your System Manager to see how your voice terminal is set.

For directions on setting or resetting your speakerphone for optimal performance, see “Setting The Speakerphone” in the next section **Features Accessed with the Display and Softkeys.**

One-Way Speaker

Use the following procedures if your voice terminal is set for the One-Way Speaker (listen only) feature.

To place/answer a call without lifting the handset or to use the one-way speaker with any listening-only feature

- 1 Press .
 - The red light next to and the red light next to go on.
- 2 Place or answer the call or access a selected feature.
- 3 If you are placing a call, dial the telephone number.
- 4 Adjust speaker volume, if necessary.
 - To raise the volume, press the right half of the Volume control button labeled ;
to lower the volume, press the left half of the Volume control button labeled .
- 5 When the other person answers, pick up the handset to talk.
- 6 Press to hang up.
 - The red light next to and the red light next to go off.

To activate the speaker while using the handset

- 1 Press .
 - The red light next to and the red light next to go on.
 - The speaker is active, and the handset is turned off.
- 2 Hang up handset.



NOTE: If you want to speak to the other party, you must pick up the handset (which turns off the speaker).

Speakerphone

Use the following procedures if your voice terminal is set for the Speakerphone (listen and speak) feature.

NOTE: If your voice terminal is set for the Speakerphone feature, you can adjust the speakerphone to the surrounding room acoustics to provide optimal performance. Use the directions in “Setting the Speakerphone” in the section titled **Features Accessed with the Display and Softkeys**.

To place/answer a call without lifting the handset or to use the speakerphone with any voice feature

- 1 Press **Speaker** .
 - The red light next to **Speaker** goes on.
- 2 Place or answer the call or access a selected feature.
- 3 If you are placing a call, dial the telephone number.
- 4 Adjust the speakerphone volume if necessary.
 - To raise the volume, press the right half of the Volume control button labeled  ;
to lower the volume, press the left half of the Volume control button labeled .
- 5 Press **Speaker** to hang up.
 - The red light next to **Speaker** goes off.

To prevent the other party from hearing you

NOTE: If the Speakerphone feature is not active, the Mute feature turns off the microphone associated with the handset (not the speakerphone).

- 1 Press **Mute** .
 - The red light goes on and the other party cannot hear you.
- 2 Press **Mute** again to resume talking to other party.
 - The red light goes off and the other party can hear you again.

Speakerphone (Continued)

To change from speakerphone to handset

- 1 Lift handset and talk.
 - The red light next to **Speaker** goes off.

To change from handset to speakerphone

- 1 Press **Speaker**.
 - The red light next to **Speaker** goes on.
 - The speaker is active, and the handset is turned off.
- 2 Hang up the handset.

TRANSFER

To send a call to another extension

- 1 Press **Transfer**.
 - The present call is put on hold.
 - The red Transfer light flutters.
- 2 Listen for dial tone.
- 3 Dial the number that the call is to be transferred to (third party).
 - Remain on the line and announce the call when the third party answers.

NOTE: If the number of the third party is busy or there is no answer, press the call appearance button next to the fluttering green light to disconnect the incomplete call and to return to the call on hold.

- 4 Press **Transfer** again.
 - The party on hold is transferred to the third party.
 - Your voice terminal is released from the call.
- 5 Hang up.

NOTE: To prevent a transfer call from disconnecting, complete the transfer process before entering into another action, such as answering another call.

Features Accessed with the Display and Softkeys

The softkeys are the four keys labeled with arrows () located directly below the display. **Figure 3** shows the softkeys in relation to the display above the softkeys and the display control buttons below them.

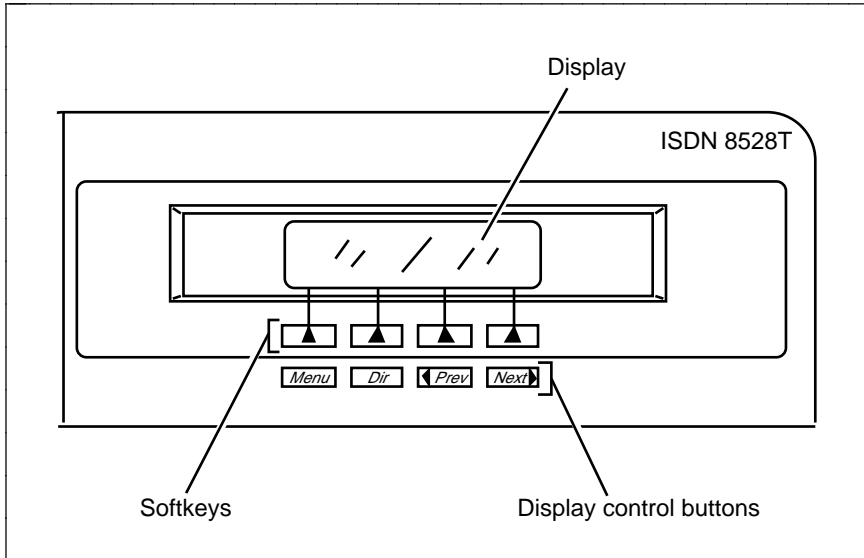



FIGURE 3 The 8528T Voice Terminal Display, Softkeys, and Display Control Buttons

You can use the softkeys and display control buttons to access the following features:

- Setting the clock;
- Setting the speakerphone;
- Adding, editing, and deleting the numbers and associated names in the voice terminal Directory;
- Viewing a Directory entry and then placing a call to the number currently shown on the display screen;
- Using the  button to quickly place a call to a number located in your Directory;
- Using the Call Log to view incoming and/or outgoing calls, and returning calls, if desired, to names and numbers listed in the incoming Call Log;
- Locking and unlocking the Directory, Call Log, and all softkey functions;

- Changing or removing your password;
- Selecting the contrast level for the display;
- Selecting a personalized ringing pattern;
- Setting the rate at which the display messages are shown on the screen;
- Adding confirmation or error tones to display messages;
- Setting the number of names on a Directory page.
- Initiating a self-test of the voice terminal's lights, ringer, buttons, and dial pad keys;

ENTERING AND EXITING SOFTKEY MODE (USING THE MENU AND THE EXIT BUTTONS)

You can begin to use the softkeys by pressing the **Menu** button. The Main Menu screen that you see looks like this:

```

      MENU >
Directory CallLog Option

```

Notice that the first line of the menu is fully capitalized, so that you know the feature that you are responding to. The second line of the voice terminal display shows the menu choices that you can select. To access any of the choices, you must press the softkey below that menu choice.

For example, by using the menu above, you can enter your Directory by pressing the leftmost softkey, the one under **Directory**. To access the voice terminal Call Log, you would press the softkey below **CallLog**. To view other softkey options, press the softkey below **Option**.

NOTE: If you press **Menu** while the Main Menu is on your display screen, you will exit Softkey mode.

If you are at any other screen, pressing **Menu** will abandon any action and return you to the Main Menu.

There are also “timed” informative screens which appear for only a few seconds. You do not need to respond to these screens. (If you press any of the softkeys during one of these timed messages, the display advances to the next message.)

Press **Exit** at any time to exit softkey mode, abandon any softkey functions in progress, and return to normal call-handling mode.

USING THE NEXT, THE PREV, AND THE DIR BUTTONS

If there is a ">" at the top right of the screen, you can press the **Next ▶** button to see the next set of menu selections. If there is a "<" at the top left of the screen, you can press the **◀ Prev** button to move back a screen on that level.

Use the **Dir** button to enter your Directory in order to quickly place a call.

RESPONDING TO QUIT AND DONE

- ▶ When you see **Quit** on the second line of the display, it means that you have the option of abandoning the action you have begun. Press the softkey below **Quit** if you do not want to respond to the options on the screen.
- ▶ When you see **Done** on the second line of the display, it means that you have already entered information or accessed a feature. Pressing the softkey below **Done** will confirm your action and allow you to move on to the next screen.

NOTE: In most of the display messages shown in this section, **Done** appears in the right lower corner, rather than **Quit**. Remember that if **Quit** is not available, you can always press **Exit** to abandon.

A SOFTKEY DISPLAY SCREEN FLOWCHART

You may wish to review the display screen flowchart in **Figure 4** before you begin using the softkey features. You may also want to return to the flowchart if you forget what a feature does or its relation to the Main Menu screen.

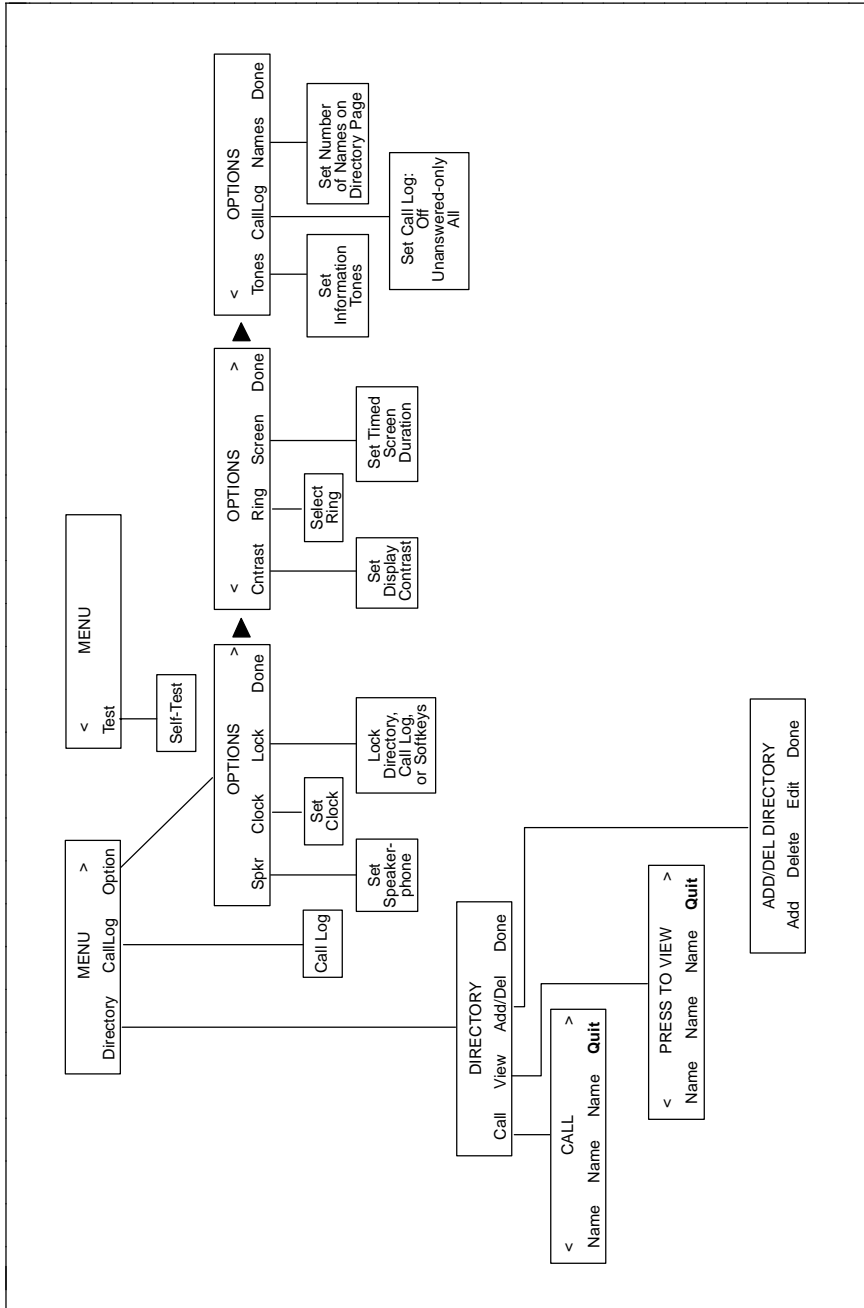

FIGURE 4 A Flowchart of the Softkey Display Screens

SETTING THE CLOCK

When your voice terminal is first installed, when it is unplugged and then plugged in again, or after a power outage, this display is shown:

```
PRESS Menu THEN Option  
TO SET THE CLOCK.
```

To set the clock

1 Press **Menu** .

- The display shows:

```
MENU >  
Directory CallLog Option
```

2 Press **▲** (the softkey) below **Option**.

- The display shows:

```
OPTIONS >  
Spkr Clock Lock Done
```



- 3 Press  (the softkey) below **Clock**.
- The display shows the date and time, such as:

Sep 24, 1995	10:00 AM	
-	+	Quit

The display format for the clock is:

MMM DD, YYYY HH:MM AM or PM

in which MMM = month abbreviation, such as "Oct"
DD = day of the month such as "02" or "24"
YYYY = year such as "1995"
HH:MM = hour and minutes such as "10:45"
AM or PM = morning or afternoon

- 4 Do the following to change the date and/or time:
- ▶ Use the softkey below **+** to go forward a month (such as from "Sep" to "Oct"), to go forward a day (such as from "24" to "25"), a year, an hour or a minute, or to switch between "AM" and "PM."
 - ▶ Use the softkey below **-** to go back a month (such as from "Sep" to "Aug"), to go back a day (such as from "24" to "23"), a year, an hour, or a minute, or to switch between "AM" and "PM."
- NOTE:** You can also use the dial pad to change the display clock. For example, when the month is flashing on the screen, you can press the  key to change the month to August, or, when the date is flashing, enter "25" from the dial pad to select "25" as the date. Use "A" for "AM" or "P" for "PM."
- ▶ The display field, which you are currently viewing, such as "Sep," flashes. To go on to the next field, such as from "Sep" (the month) to "24" (the day), press . The **Quit** menu choice at the lower right corner changes to **Done**.
- 5 *When the correct date appears on the display*, press the softkey below **Done**.
- The display confirms your changes.
- 6 Once the clock has been set, you can now set the speakerphone. Go on to the next procedure, "Setting the Speakerphone."

The following procedure is an alternate way of using the softkeys to set the speakerphone.

- 1 Press **Menu** .
- 2 Press the softkey below **Option**.
 - The display shows:

```
OPTIONS >
Spkr Clock Lock Done
```

- 3 Press the softkey below **Spkr**.
 - The display shows:

```
OPTIMIZING PERFORMANCE
OF THE SPEAKERPHONE.
```

- You hear a set of rising tones as the speakerphone adjusts itself to the surrounding acoustical environment. *These tones are automatic. No user response is required.*

ADDING, EDITING, AND DELETING A NUMBER AND NAME IN THE DIRECTORY

The 8528T voice terminal supports up to 30 Directory entries. The telephone numbers entered in the Directory can be up to 24 digits, and associated names can be up to five characters in length. Directory entries can be changed by deleting or editing.

When you enter names into your Directory, the entries are automatically alphabetized for you.

NOTE: If there are frequently used names that you want to place at the front of your Directory, place a # or * as the first character in the name such as "#KimB" or "*Dan." These names will then appear before the "A's" in your Directory. (Names beginning with # appear first in the Directory, followed by names beginning with *, and then names beginning with a number, 0 through 9, and then the alphabet.)

Adding Numbers and Names Into the Directory

To enter/add a number and name into the Directory

- 1 Press **Menu** .
- 2 Press the softkey below **Directory**.
- 3 Press the softkey below **Add/Del**.

NOTE: If the Directory is locked, you must enter your 3-digit password in order to modify your Directory. See the information in "Locking and Unlocking the Directory, Call Log, and All Softkeys" later in this section.

- The display shows:

ADD/DEL DIRECTORY
Add Delete Edit Done

- 4 Press the softkey below **Add**.

- The display shows:

ENTER PHONE # : _
Pause Quit

- 5 Enter the telephone number you want to be added to the Directory. (You can enter up to 24 digits. A pause counts as 1 digit.)

NOTE: To place a 1.5 second pause between an access code, such as "9," and the telephone number, press the softkey below **Pause**. A pause will be inserted into the Directory entry, and a comma will appear on the display.

- After you have entered at least one digit, you will see the following display:

ENTER PHONE # : 9 _
Pause Backspace Done

IMPORTANT: Hyphens, dashes and/or spaces are NOT necessary between digits. (For example, in the Directory, the number, 555-1234, is entered as "5551234," without the intervening hyphen.)



NOTE: After you have entered 10 digits, including any pauses, the words, "Enter Phone #:" begin to move off the display screen one letter at a time in order to accommodate the remainder of the telephone number.

When you are finished entering the phone number, press the softkey below **Done** .

- The display shows:

ENTER 5-CHAR NAME : _
Quit

- 6 Use the dial pad keys to enter the name of the person whose number you have just added to the Directory. Pressing the softkey below **Quit** now will abandon the procedure. The number you entered will not be saved.

IMPORTANT: You may need to press the dial pad key more than once to enter the correct character. For example, press the **GHI** (or ) key once to enter a "G"; press the  key twice to enter an "H"; press the key a third time to enter an "I." If you press the dial pad key a fourth time, a "4" appears on the screen. If you press the  key again, the screen will again print a "G."

You can also use a # or a * at the beginning of or within the name.

Once the letter on the screen is correct, you *must* press  to enter the next letter.

- After you have entered at least one character, the following display appears:

```
ENTER 5-CHAR NAME:A
Case DeleteChar Done
```

NOTE: As you enter each letter of the name, that letter flashes on the screen until you move on to the next letter.

- ▶ When a letter is flashing, use **Case** to switch between UPPER CASE and lower case letters. Of course, you may have a combination of both in your 5-character name (such as Steve or HarvW).
- ▶ When a letter is flashing, use **DeleteChar** to erase that letter.
- ▶ Use  to advance to the next letter.

```
ENTER 5-CHAR NAME:A_
Backspace Done
```

- ▶ When **Backspace** appears on the second line of the display, you can use this feature to go back one space and erase the previous letter.

- 7 When you are finished entering the name, press the softkey below **Done**.
 - The display confirms your entry.

Editing Entries in the Directory

To edit a Directory entry

- 1 Press **Menu** .
- 2 Press the softkey below **Directory**.
- 3 Press the softkey below **Add/Del**.

NOTE: If the Directory is locked, you must enter your 3-digit password in order to modify your Directory. (See the information in “Locking and Unlocking the Directory, Call Log, and All Softkeys” later in this section.)

- The display shows:

```
ADD/DEL DIRECTORY
Add Delete Edit Done
```

- 4 Press the softkey below **Edit** in order to edit a Directory entry.
 - The display shows:

```
< SELECT TO EDIT >
EdBks HarvW Steve Quit
```

NOTE: Once again, remember that the names in the Directory are arranged alphabetically.

- 5 Do the following:
 - ▶ Press **Next ▶** to page forward through the names in the Directory.

- ▶ Press **◀ Prev** to page backwards through the names in the Directory.
- 6 Press the softkey below the name of the entry you want to edit.
- The display shows:

```
EDIT 5-CHAR NAME: Harv_  
Backspace Done
```

- 7 If the phone number is correct and you don't wish to edit it at this time, press the softkey below **Done**.

If you want to edit the name, do the following:

- ▶ You may need to press the dial pad key more than once to enter the correct character. For example, press the **GHI** (or **4**) key once to enter a "G"; press the **4** key twice to enter an "H"; press the key a third time to enter an "I." If you press the dial pad key a fourth time, a "4" appears on the screen. If you press the **4** key again, the screen will again print a "G."
 - ▶ Use **Next ▶** to advance to the next letter.
 - ▶ Press the softkey below **Backspace** to move back and erase the previous letter.
 - ▶ Press **◀ Prev** to move back a letter without erasing it.
- 8 When you have completed entering the 5-character name, press the softkey below **Done**.
- The display then shows:

```
EDIT PHONE #:5551234_  
Pause Backspace Done
```

- 9 If the phone number is correct and you don't wish to edit it at this time, press the softkey below **Done**. (You are done editing a Directory entry.)

If you want to edit the phone number, do the following:

- ▶ To move back and erase a number, press the softkey below **Backspace**.

- ▶ To move back without erasing a number, press ◀ Prev .
- ▶ To erase the flashing number, press the softkey below **Delete**.
- ▶ To move forward without erasing a number, press Next ▶ .
- ▶ To enter new or corrected numbers, press the appropriate dial pad keys.
- ▶ Press the softkey below **Pause** to insert a 1.5-second pause in the telephone number. Each pause in the number is represented on the screen by a comma.
- ▶ When you have completed editing the telephone number, press the softkey below **Done**.
 - The display confirms your choice.

Deleting an Entry from the Directory

To delete an entry from the Directory

- 1 Press Menu .
- 2 Press the softkey below **Directory**.
- 3 Press the softkey below **Add/Del** to add or delete a Directory entry.

NOTE: If the Directory is locked, you must enter your 3-digit password in order to modify your Directory. (See the information in “Locking and Unlocking the Directory, Call Log, and All Softkeys” later in this section.)

- The display shows:

ADD/DEL DIRECTORY			
Add	Delete	Edit	Done

4 Press the softkey below **Delete**.

- The display shows:

```
<  SELECT TO DELETE  >
EdBks HarvW Steve Quit
```

5 Do the following:

- ▶ Press **Next ▶** to page forward through the names in the Directory.
- ▶ Press **◀ Prev** to page backwards through the names in the Directory.

6 Press the softkey below the name of the entry you want to delete.

- The display shows:

```
5551234
HarvW          Delete Quit
```

7 Press the softkey below **Delete** if you want to delete this entry.

- The display confirms your choice.

VIEWING A DIRECTORY ENTRY (AND PLACING A CALL)

Directory entries can be viewed and changed, or you can exit the Directory and have the voice terminal automatically dial the telephone number you are presently viewing.

To view a Directory entry (and, if desired, call that number)

NOTE: You can also use the **Dir** button to call a number in your Directory. To do this, use the procedures in “Using the Dir Button to Place a Call.”

- 1 Press **Menu** .
- 2 Press the softkey below **Directory**.
 - The display shows:

```
DIRECTORY
Call  View Add/Del Done
```

- 3 Press the softkey below **View**.
 - The display shows:

```
<  PRESS TO VIEW  >
EdBks HarvW Steve Quit
```

- 4 Do the following:
 - ▶ Press **Next ▶** to page forward through the names in the Directory.
 - ▶ Press **◀ Prev** to page backwards through the names in the Directory.

- 5 Press the softkey below the Directory entry of the name you want to view.
- The display shows:

```
5551234
HarvW Call Edit/Del Done
```

NOTE: The name of the person associated with this telephone number, such as **HarvW**, is shown in the lower left corner.

- 6 Do one of the following:
- ▶ To call this number, press the softkey below **Call**.
 - The voice terminal exits softkey mode and dials the telephone number you are currently viewing on the screen.
 - ▶ If you want to edit or delete the Directory entry, press the softkey below **Edit/Del**.
 - The display shows:

```
EDIT/DELETE HarvW
Edit Delete      Quit
```

If you want to edit the Directory entry, press the softkey under **Edit**. If you want to delete the Directory entry, press the softkey below **Delete**. (If you need help in editing or deleting the Directory entry, return to the directions in “Adding, Editing, and Deleting a Number and Name in the Directory.”)

- 7 If you have completed viewing the telephone number, press the softkey below **Done**.

USING THE DIR BUTTON TO PLACE A CALL

You can also use the **Dir** button to place a call to a number entered in your Directory.

IMPORTANT: When you press the softkey under the name in the Directory you wish to call, the call is placed *immediately*. *The menu does not ask you to respond to a screen before the call is placed.*

To use the Dir button to call a person whose number appears in your Directory

- 1 Press **Dir** to enter your Directory.
 - The display shows:

```
<          CALL          >
EdBks HarvW Steve Quit
```

NOTE: The word “CALL” flashes to remind you that if you press a softkey below a name, it will automatically call that entry.

- 2 Do the following:
 - ▶ Press **Next ▶** to page forward through the names in the Directory.
 - ▶ Press **◀ Prev** to page backwards through the names in the Directory.
- 3 When the name of the person whose number you want to call appears on the second line of the screen, press the softkey below that name.
 - The voice terminal exits softkey mode and dials the telephone number you have selected *immediately*.

USING THE CALL LOG

The voice terminal Call Log stores the 10 most recent unanswered incoming calls, the 10 most recent answered incoming calls, and the 10 most recent calls that were placed at the voice terminal.

NOTE: If multiple calls from the same telephone number are received, only the most recent call from that number appears in the Call Log.

When an eleventh call comes in or is placed, it is added to the top of the Call Log in the appropriate category; the call listed at the bottom of the list in that category is deleted from the list.

When your voice terminal arrives and is initially set up, it will have only an Unanswered Call Log. If you want to readjust your own Call Log, see the procedures in the sub-section titled "Setting the Call Log." You may designate whether you want to:

- View **only incoming unanswered calls** in your Call Log;
- **Turn off** the Call Log;
- View **all calls**, incoming and outgoing, in your Call Log.

NOTE: Incoming Call Log will reflect information provided by the network your voice terminal is connected to. If no information appears in your Call Log, see your system manager.

For all incoming calls, you may also choose to activate the Callback feature which allows you to return calls to callers listed in your incoming Call Log. You may also choose to activate the AutoAdd feature. With this feature the voice terminal automatically saves the names and numbers in your incoming Call Log and adds them to your Directory.

**Viewing Unanswered Incoming Calls in the Call Log
(When the Call Log is set to Unanswered Calls Only)**

To view the 10 most recent unanswered calls (with Call Log set to “Unanswered Only”)

1 Press **Menu** .

2 Press the softkey below **CallLog**.

NOTE: If the Call Log is locked, you will need to enter your 3-digit password before you can use the Call Log. (See the information in “Locking and Unlocking the Directory, Call Log, and All Softkeys” later in this section.)

- The display shows:

```
UNANSWERED CALL LOG
New   Old           Done
```

NOTE: The words, “New” or “Old” appear on the second line only if you have new or old calls in your voice terminal’s Call Log.

3 Press the softkey below **New** or below **Old** according to the unanswered calls you want to view at this time.

- The display shows:

```
555-1235          P.Feher >
Time Delete      More
```

- If your terminal is able to place calls to numbers in the incoming Call Log, the display will show:

```
555-1235          P.Feher >
Time Call Save More
```

NOTE: If the number and the name of the caller cannot be identified, you will see the message, "Phone#/Name Unavailable" on your display screen. (The name is present only if it's an internal call.)

- 4 If you want to see the time at which this call rang at your voice terminal, press the softkey below **Time**.
- 5 If **Delete** is displayed, you may press the softkey below it to remove this call from the Call Log.
- 6 If **Call** is displayed, you may press the softkey below it to exit softkey mode and place a call to this number.

NOTE: Not all telephone numbers can receive calls. Often the displayed number may represent the outgoing trunk of a building. Calls placed to such numbers will result in error tones or indefinite ringing. The phone will automatically insert an outside-line access code or remove unnecessary numbers as long as you have dialed these types of calls at some point.

- 7 If **Save** is displayed, you may press the softkey below it to add it to your Directory.

NOTE: If you have activated the AutoAdd feature, the name and number of incoming callers will automatically be saved in your Directory.

- The display shows:

EDIT PHONE #:5551234_ Pause Backspace Done

NOTE: After editing the phone number and pressing the softkey below **Done**, you are prompted to enter a 5-character name associated with that number. If you need help in editing (or entering the name into) the Directory entry, return to the directions in "Adding, Editing, and Deleting a Number and Name in the Directory."

- 8 If you want to see information on the next or previous call in the Call Log, press the softkey below **More** or press **Next ▶** or **◀ Prev** .
 - The display shows you the number and name of the next or previous unanswered call in the Call Log.
 - The display tells you when you have finished viewing all the new unanswered calls in the Call Log.

- 9 When you are finished viewing each unanswered call in the Call Log, press the softkey below **More** until you reach the end of that list. Then press the softkey below **Done**.

NOTE: After you have viewed new calls in the Call Log, they become old calls. The Call Log will continue to hold the 10 most recent unanswered calls.

Setting the Call Log

To turn on or to turn off, or to set the Call Log

- 1 Press **Menu** .
- 2 Press the softkey below **Option**.
- 3 Press **Next** twice to view the third Option screen.
 - The display shows the third option screen:

```
<      OPTIONS
Tones CallLog Names Done
```

- 4 Press the softkey below **CallLog**.

NOTE: If the Call Log is locked, you will need to enter your 3-digit password before you can use the Call Log. (See the information in “Locking and Unlocking the Directory, Call Log, and All Softkeys” later in this section.)

- The display shows:

```
CALL LOG OPTIONS >
Set-up Indicator Done
```

- 5 To set up your Call Log (turn Call Log off, logs only unanswered calls, or logs all calls), press the softkey below **Set-up**.

- The display shows the current status of the Call Log:

```
CALL LOG:UNANSWERED ONLY
Off Unansw All Done
```

6 Do one of the following:

- ▶ If you do not want your voice terminal to collect Call Log information, press the softkey below **Off**.
- ▶ If you want to have only unanswered calls entered into the Call Log, press the softkey below **Unansw**.
- ▶ If you want both unanswered and answered incoming calls and all outgoing calls to be entered into your Call Log, press the softkey below **All**.
- The display shows you the Call Log setting you have selected.

7 If the correct Call Log setting appears on your screen, press the softkey below **Done**.

- The display confirms your choice.
- If the Call Log is turned off, the display asks you to confirm your choice to clear and turn off the Call Log.

If you press the softkey below **Yes**, your Call Log is cleared and then turned off, and the word "CallLog" will not appear on the Main Menu.

***Seeing Indication of New Unanswered Incoming Call(s)
Under the Date and Time on Your Display Screen***

You can set your display so that you receive an indication when a new unanswered incoming call is placed into your Call Log.

```
Sep 24, 1995 10:00 AM
(TWO NEW CALLS LOGGED.)
```

To set your display so that you receive an indication of new unanswered incoming calls on the second line of the display

- 1 Press **Menu** .
- 2 Press the softkey below **Option**.
- 3 Press **Next** twice to view the third Option screen.
 - The display shows the third option screen:

```
<          OPTIONS
Tones CallLog Names Done
```

- 4 Press the softkey below **CallLog**.

NOTE: If the Call Log is locked, you will need to enter your 3-digit password before you can use the Call Log. (See the information in “Locking and Unlocking the Directory, Call Log, and All Softkeys” later in this section.)

- The display shows:

```
CALL LOG OPTIONS >
Set-up Indicator Done
```

- 5 Press the softkey below **Indicator**.

- The display shows:

```
SHOW NEW CALL INDICATOR?
Yes   No       Explain
```

- 6 Press the softkey below **Yes** or **No**.

NOTE: If you press the softkey below **Explain**, you can read more information on the indicator feature.

- If you press **No**, the display returns you to the original “Call Log Options” screen; if you press **Yes**, the display confirms that you will receive indication when a new unanswered incoming call arrives.

Returning Calls to Callers Listed in Your Incoming Call Log

To be able to call back people whose names and numbers appear in your incoming Call Log:

- 1 Press **Menu** .
- 2 Press the softkey below **Option**.
- 3 Press **Next ▶** twice to view the third Option screen.
 - The display shows the third option screen:

```
<          OPTIONS
Tones CallLog Names Done
```

- 4 Press the softkey below **CallLog**.

NOTE: If the Call Log is locked, you will need to enter your 3-digit password before you can use the Call Log. (See the information in “Locking and Unlocking the Directory, Call Log, and All Softkeys” later in this section.)

 - The display shows:

```
CALL LOG OPTIONS >
Set-up Indicator Done
```

- 5 Press **Next ▶** .

- The display shows:

```
< CALL LOG OPTIONS
CallBack  AutoAdd Done
```

- 6 If you want to be able to call back callers in your incoming Call Log, press the softkey below **CallBack**.

- The display shows the current setting for the CallBack feature and allows you to change it:

```
CALL FROM INCOMING: No
Yes      No Explain Done
```

- 7 If the CallBack feature is set to No, you can change the setting to Yes by pressing the softkey below **Yes**.

NOTE: By setting the CallBack feature option to Yes, you can call back callers in your incoming Call Log. This setting will be active until you change the CallBack setting to No.

If you press the softkey below **Explain**, you can read more information on the indicator feature.

- 8 When the display shows the CallBack setting you prefer (Yes or No), press the softkey below **Done**.

- If you activate the CallBack feature, the display message asks you for your areacode:

```
ENTER AREACODE : _
Pause  Backspace  Done
```

or, if the voice terminal has already determined the areacode from past calls which you have placed, the display message asks you to confirm your areacode:

IS YOUR AREACODE 607 ?	
Yes	No

- 9 Enter your areacode and then press the softkey below **Done** or press the softkey below **Yes** to verify your areacode.
 - The display confirms that you will now be able to return calls to numbers in your incoming Call Log.

Automatically Adding Names and Numbers from Incoming Calls to Your Directory

To automatically add incoming callers to your Directory:

- 1 Press **Menu** .
- 2 Press the softkey below **Option**.
- 3 Press **Next** twice to view the third Option screen.
 - The display shows the third option screen:

<	OPTIONS		
Tones	CallLog	Names	Done

4 Press the softkey below **CallLog**.

NOTE: If the Call Log is locked, you will need to enter your 3-digit password before you can use the Call Log. (See the information in "Locking and Unlocking the Directory, Call Log, and All Softkeys" later in this section.)

- The display shows:

```
CALL LOG OPTIONS >
Set-up Indicator Done
```

5 Press **Next ▶** .

- The display shows:

```
< CALL LOG OPTIONS
CallBack AutoAdd Done
```

6 Press the softkey below **AutoAdd**.

- The display shows:

```
SAVE INCOMING TO DIR?No
Yes No Explain Done
```

7 If you want to automatically add the names and numbers of incoming calls to your Directory, press the softkey below **Yes**.

NOTE: If you select the Yes option, the names and numbers of incoming callers will automatically be added to your Directory until you change the AutoAdd setting to No.

- 8 When the display shows the AutoAdd setting you prefer (Yes or No), press the softkey below **Done**.
- If you activate the AutoAdd feature, the display message asks you for your areacode:

```
ENTER AREACODE : _  
Pause  Backspace  Done
```

or, if the voice terminal has already determined the areacode from past calls which you have placed, the display message asks you to confirm your areacode:

```
IS YOUR AREACODE 607 ?  
Yes                No
```

- 9 Enter your areacode and then press the softkey below **Done** or press the softkey below **Yes** to verify your areacode.
- The display confirms that incoming calls will be added to your Directory.

**Viewing Unanswered Incoming Calls in the Call Log
(When Call Log is set to All Calls)**

Use the following procedures when the Call Log is set for “All Calls.”

To view the 10 most recent unanswered calls (when the Call Log is set to “All Calls”)

1 Press **Menu** .

2 Press the softkey below **CallLog**.

NOTE: If the Call Log is locked, you will need to enter your 3-digit password before you can use the Call Log. (See the information in “Locking and Unlocking the Directory, Call Log, and All Softkeys” later in this section.)

- The display shows:

(New)	CALL LOG
Incoming	Outgoing Done

NOTE: The word “New” means that there are new unanswered calls since the last time you checked the Call Log for unanswered incoming calls.

3 Press the softkey below **Incoming**.

- The display shows:

(New)	INCOMING
Unanswered	Answered Done

4 Press the softkey below **Unanswered**.

- The display tells you the number of new unanswered calls added to your Call Log.

- Then the display shows you the number (and name, if it is an internal call) such as:

```
555-1235      P.Feher >
Time Delete      More
```

- If your terminal is able to place calls to numbers in the incoming Call Log, the display will show:

```
555-1235      P.Feher >
Time Call Save More
```

- 5 If you want to see the time at which the call rang at your voice terminal, press the softkey below **Time**.
- 6 If **Delete** is displayed, you may press the softkey below it to remove this call from the Call Log.
- 7 If **Call** is displayed, you may press the softkey below it to exit softkey mode and place a call to this number.

NOTE: Not all telephone numbers can receive calls. Often the displayed number may represent the outgoing trunk of a building. Calls placed to such numbers will result in error tones or indefinite ringing. The phone will automatically insert an outside-line access code or remove unnecessary numbers as long as you have dialed these types of calls at some point.

- 8 If **Save** is displayed, you may press the softkey below it to add the number to your Directory.

NOTE: If you have activated the AutoAdd feature, the name and number of incoming callers will automatically be saved in your Directory.

- The display shows:

```
EDIT PHONE #:5551234_
Pause Backspace Done
```

NOTE: After editing the phone number, you are prompted to enter a 5-character name associated with that number. If you need help in editing (or entering the name into) the Directory entry, return to the directions in “Adding, Editing, and Deleting a Number and Name in the Directory.”

- 9 If you want to see information on the next or previous call in the Call Log, press the softkey below **More** or press `Next ▶` or `◀ Prev` .
 - The display shows you the number and/or name of the next or previous unanswered call in the Call Log.
 - The display informs you when you have viewed all of the new or old calls.
- 10 When you are finished viewing each call, press the softkey below **More** until you reach the end of the list. Then press the softkey below **Done**.

Viewing Answered Incoming Calls in the Call Log

To view the list of the 10 most recent answered calls

- 1 Press `Menu` .
- 2 Press the softkey below **CallLog**.

NOTE: If the Call Log is locked, you must enter your 3-digit password to modify your Call Log. (See the information in “Locking and Unlocking the Directory, Call Log, and All Softkeys” later in this section.
- 3 Press the softkey below **Incoming** to view incoming calls.
 - The display shows:

(New)	INCOMING
Unanswered	Answered Done

- 4 Press the softkey below **Answered** to view incoming answered calls in your Call Log.
 - The display shows you the most recent answered call:

555-1235	P.Feher >
Time Delete	More

NOTE: The number shown at the top left, such as “555-1235,” is the telephone number of the answered call. The name of the person associated with that number is shown at the right of the first line.

- If your terminal is able to place calls to numbers in the Call Log, the display will show:

555-1235	P.Feher >
Time Call Save	More

- 5 If you want to see when the call was answered, press the softkey below **Time**.
- 6 If **Call** is displayed, you may press the softkey below it to exit softkey mode and place a call to this number.

NOTE: Not all telephone numbers can receive calls. Often the displayed number may represent the outgoing trunk of a building. Calls placed to such numbers will result in error tones or indefinite ringing. The phone will automatically insert an outside-line access code or remove unnecessary numbers as long as you have dialed these types of calls at some point.

- 7 If **Save** is displayed, you may press the softkey below it to add the telephone number to your Directory.

NOTE: If you have activated the AutoAdd feature, the name and number of incoming callers will automatically be saved in your Directory.

- The display shows:

```
EDIT PHONE #:5551234_  
Pause Backspace Done
```

NOTE: After editing the phone number, you are prompted to enter a 5-character name associated with that number. If you need help in editing (or entering the name into) the Directory entry, return to the directions in “Adding, Editing, and Deleting a Number and Name in the Directory.”

- 8 If you want to see more of the most recent calls you have answered, press the softkey below **More** or press **Next ▶** or **◀ Prev** .
 - The display again shows you the telephone number of the next or previous incoming call.
 - The display informs you when you have viewed all of the answered calls in your Call Log.
- 9 When you are finished viewing each answered call in the Call Log, press the softkey below **More** until you reach the end of the list. Then press the softkey below **Done**.

Viewing Outgoing Calls in the Call Log

To view the 10 most recent calls placed from the voice terminal

- 1 Press **Menu** .
- 2 Press the softkey below **CallLog**.
 - This display shows:

```
CALL LOG  
Incoming Outgoing Done
```

- 3 Press the softkey below **Outgoing** to view the list of calls you have placed.

- The display shows one of the following screens, according to whether you have entered both a name and a number into the Directory entry (it makes no difference whether you dialed the number from the dial pad or the Directory or used **Redial**):

```
555-1237          Steve >
Time  Call        More
```

or

```
555-1236          >
Time  Call  Save  More
```

NOTE: The telephone number shown here is the number of the call placed from this voice terminal, such as 555-1237 or 555-1236. The name of the person associated with that number, such as in the first example directly above (the name “Steve” appears there), is shown at the right of the first line (if one has been entered into the personalized Directory).

- 4 Do one of the following:
 - ▶ If you press the softkey below **Time**, the display will show you the time the call was placed.
 - ▶ If you press the softkey below **Call**, the voice terminal exits Softkey mode and places a call to this number.
 - ▶ If there is *not* a name associated with the number, it means that this number is not in your Directory. If you want this number entered into your Directory, press the softkey below **Save**.
 - The display shows:

```
EDIT PHONE #:5551234_
Pause  Backspace  Done
```

- After editing the phone number, you are prompted to enter a 5-character name associated with that number.

NOTE: If you need help in editing (or entering the name into) the Directory entry, return to the directions in “Adding, Editing, and Deleting a Number and Name in the Directory.”

- ▶ You can view other outgoing calls placed at the voice terminal by pressing the softkey below **More** or by pressing **Next ▶** or **◀ Prev**. The display informs you when you have viewed all the new outgoing calls in the Call Log.
- 5 When you are finished viewing each outgoing call in the Call Log, press the softkey below **More** until you reach the end of the list. Then press the softkey below **Done**.

LOCKING AND UNLOCKING THE DIRECTORY, CALL LOG, AND ALL SOFTKEYS

The 8528T voice terminal allows you the option of locking the following:

- You can **lock the Directory** so that no one can make unauthorized changes to it;
- You can **lock the Call Log** so no one can view your incoming or outgoing calls or change your Call Log options;
- You may also choose to **lock all the softkeys** so that no one can view or change any of the features accessed by the softkeys.

In order to lock any (or all) of these features, you must enter your own personal 3-digit security password. As you enter the 3 digits, a * appears in place of each digit. In this way, your password remains private.

NOTE: Your password remains the same for all three features.

If you *access* a locked feature by entering a password, the feature will automatically relock when you exit that feature. You must use your password every time you want to *access* that locked feature until you use the lock option to *unlock* that feature.

To lock your Directory, Call Log, or all softkeys

- 1 Press **Menu** .
- 2 Press the softkey below **Option**.
 - The display shows:

OPTIONS	>
Spkr Clock Lock Done	

- 3 Press the softkey below **Lock**.

- The display shows:

LOCK	
Select-Item	Done

4 Press softkey below **Select-Item**.

- The display shows:

SELECT ITEM TO LOCK >	
CallLog Directory	Done

- or if you press , the display shows the next “Select Item” screen:

< SELECT ITEM TO LOCK	
Softkeys	Done

5 Press the softkey below **CallLog** or **Directory** or **Softkeys** according to which one you want to lock.

- The display asks you to confirm your choice (Yes or No) in order to lock the Directory, Call Log, or softkeys.

NOTE: If you press the softkey below **Explain**, you can read more information on the locking feature.

- 6 If you press **No**, the display returns you to the original “Select Item To Lock” screen; if you press **Yes**, the display asks you to enter or create a 3-digit password.
- 7 Enter or create your 3-digit password.

- 8 When you have entered your password, press the softkey below **Done**.

When you have created a password, the display asks you to "Please Re-enter the Password." When you have completed that task, press the softkey below **Done**.

- The display confirms that you have locked the feature of your choice.

To unlock your Directory

NOTE: If you have lost your password, see your system manager.

- 1 Press **Menu** .
- 2 Press the softkey below **Option**.
 - The display shows:

```
OPTIONS >
Spkr Clock Lock Done
```

- 3 Press the softkey below **Lock**.
 - The display shows:

```
LOCK
Select-Item Done
```

4 Press softkey below **Select-Item**.

- The display shows:

```
SELECT ITEM TO LOCK >
CallLog Directory Done
```

- or if you press , the display shows the next "Select Item" screen:

```
< SELECT ITEM TO LOCK
Softkeys Done
```

5 Press the softkey below **CallLog** or **Directory** or **Softkeys** according to which one you want to unlock.

- The display message tells you that the feature is locked and asks you to confirm your choice (Yes or No) in order to unlock the Directory, Call Log, or softkeys.

6 If you press **No**, the display returns you to the original "Select Item To Lock" screen; if you press **Yes**, the display asks you to enter a 3-digit password.

7 Enter your 3-digit password.

8 When you have entered your password, press the softkey below **Done**.

- The display confirms that you have unlocked the feature of your choice.

CHANGING OR REMOVING YOUR PASSWORD

To change or remove a 3-digit security password

- 1 Press **Menu** .
- 2 Press the softkey below **Option**.
 - The display shows:

```
OPTIONS >
Spkr Clock Lock Done
```

- 3 Press the softkey below **Lock**.
 - The display shows:

```
LOCK
Select-Item Pswd Done
```

- 4 Press softkey below **Pswd**.
 - The display shows:

```
PASSWORD
Change Remove Done
```

- 5 Do one of the following:
- ▶ If you want to change your password, press the softkey below **Change**.
 - The display messages ask you to enter your old password, create a new password, and re-enter the new password.
 - When you have done this, the display confirms that the new password is now active.
 - ▶ If you want to remove your 3-digit password, press the softkey below **Remove**.
 - The display asks you to enter your 3-digit password.
 - When you have entered the password, the display confirms that the password is removed and everything is unlocked.

CHOOSING THE CONTRAST LEVEL FOR THE DISPLAY

You can use the softkeys to set the darkness or lightness of the voice terminal display.

To choose the contrast level of the display

- 1 Press **Menu** .
- 2 Press the softkey below **Option**.
- 3 Press **Next ▶** to view the second Options screen.
 - The display shows:

```
<          OPTIONS          >
Cntrast Ring Screen Done
```

- 4 Press the softkey below **Contrast**.
 - The display shows:

```
CONTRAST: L>>>>H
-          +          Done
```

NOTE: The arrows are arranged between **Low** and **High**. There are five possible contrast levels, and thus five possible arrows between **L** and **H**.

- 5 Press the softkey below - or ◀ *Prev* to make the contrast lighter. Each button press decreases the number of arrows by one.
Press the softkey below + or *Next* ▶ to make the contrast darker. Each button press increases the number of arrows by one.
- 6 Press the softkey below **Done** when you are finished.
 - The display confirms that the contrast level has been set.

SELECTING A PERSONALIZED RING

You can use the softkeys to choose a personalized ringing pattern for your voice terminal so you can distinguish the ringing pattern at your voice terminal from others in your office. There are eight different ringing patterns to choose from.

To select a personalized ringing pattern for your voice terminal

- 1 Press **Menu** .
- 2 Press the softkey below **Option**.
- 3 Press **Next ▶** to view the second Options screen.
 - The display shows:

```
<          OPTIONS          >
Cntrast Ring Screen Done
```

- 4 Press the softkey below **Ring**.
 - The display shows:



```
SELECT RING PATTERN: 1
-          +          Done
```

NOTE: The number “1” in this sample screen is the number of the ringing pattern you are currently hearing.

- 5 Press **-** or **+** or dial the number from the dial pad to hear ringing patterns 1 through 8.
 - Each of the eight ringing patterns is played once.

- 6 When you hear the ringing pattern you want to use for your voice terminal, press the softkey below **Done**.
 - The display confirms the ringing pattern you have chosen.

To adjust the ring volume (this may be adjusted only when you are *not* on a call)

- 1 To raise the volume, press the right half of the Volume control button labeled ; to lower the volume, press the left half of the Volume control button labeled .

SETTING THE RATE AT WHICH YOU VIEW THE DISPLAY MESSAGES

You can use the softkeys to set the length of time the display message stays on the screen. When you receive your voice terminal, the rate is set to Medium. However, there are actually three rate settings: Slow, Medium, and Fast. You may want to test all three reading rates before you make a final selection.

To select the rate at which you see the display messages

- 1 Press **Menu** .
- 2 Press the softkey below **Option**.
- 3 Press **Next** to view the second Option screen.
 - The display shows:

```
<          OPTIONS          >
Cntrast Ring Screen Done
```

- 4 Press the softkey below **Screen**.
 - The display shows the current rate:

```
TIMED MESSAGE RATE: MED
Slow  Med   Fast  Done
```

- 5 Press the softkey below either **Slow**, **Medium**, or **Fast**, according to the rate at which you want the display messages to be shown.
 - The display reflects the choice you have made.
- 6 When the display screen shows the display message rate you want, press the softkey below **Done**.

NOTE: Be sure to check the timing of the message for the rate at which you have set the messages to be displayed. If it is too fast or too slow, you may modify the rate again.

TURNING ON OR OFF SOFTKEY INFORMATION TONES

Along with timed confirmation screens, the voice terminal also provides softkey mode confirmation tones (sequential low and high tones). Also available are error tones (one beep) to alert you if you have made a mistake in your softkey entries. You may choose to turn these softkey information tones on or off.

NOTE: This procedure turns on or off the information tones *associated with the softkeys*. The confirmation and error tones associated with those features *not* used with the softkeys are not turned on or off by the procedure described here.

To turn on or off the confirmation and error tones

- 1 Press **Menu** .
- 2 Press the softkey below **Option**.
- 3 Press **Next** twice to view the third Options screen.
 - The display shows:

```
<          OPTIONS
Tones CallLog Names Done
```

- 4 Press the softkey below **Tones**.
 - The display shows the current setting (On or Off):

```
INFORMATION TONES: OFF
Off      On          Done
```

- 5 Press the softkey below **Off** to turn off the softkey mode information tones, or press the softkey below **On** to turn on the information tones.
 - The display changes to reflect your choice (On or Off).

6 When the display screen reflects your choice (On or Off), press the softkey below **Done**.

NOTE: Even if you choose to turn off the softkey mode information tones, you will still hear the confirmation and error tones associated with the voice features (features not accessed with the softkeys).

SETTING THE NUMBER OF NAMES ON THE DIRECTORY PAGE

When you view the names in your Directory or use **Dir** to locate the name of someone in your Directory whom you want to call, you will initially see three names and the word **Quit** on the second line of each Directory page, such as in the following two screens.

```
<  PRESS TO VIEW  >
EdBks HarvW Steve Quit
```

```
<          CALL          >
EdBks HarvW Steve Quit
```

However, you may choose to change this option so that you can view four names (instead of three) on the second line of each Directory page.

Your "Number of Names" options are these:

- If you choose "**3+Quit**," you will see three names on each Directory page. You can quit viewing more names in the Directory or decide not to call a name in your Directory (when you have used **Dir**), by pressing the softkey below **Quit**.
- If you choose "**4**," you will see four names on each Directory page, but, if you decide not to view more names in the Directory or in order to cancel calling a name (when you have used **Dir**), you must press **Exit** .

NOTE: This option sets the number of names (either three or four) on each Directory page. It *does not* affect the maximum number of entries (which is 30) you can maintain in your Directory.

To set the number of names (3 or 4) on an individual Directory page

- 1 Press **Menu** .
- 2 Press the softkey below **Option**.
- 3 Press **Next** twice to view the third Options screen.
 - The display shows:

```
<          OPTIONS
Tones CallLog Names Done
```

- 4 Press the softkey below **Names**.
 - The display shows the current setting (“3+Quit” or “4”):

```
NAMES PER PAGE: 3+Quit
 3      4   Explain Done
```

- 5 Press the softkey below **4** if you want to view four names on each Directory page. Press the softkey below **3** if you want to see three names (and **Quit**).
 - The display changes to reflect your choice (“3+Quit” or “4”).
- 6 When the display screen reflects your choice, press the softkey below **Done**.

SELF-TEST

If you press **Next** while the Main Menu is on the display screen, the following menu screen appears:

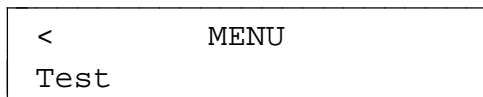

If you press the softkey below **Test**, you can perform a test of your voice terminal's lights, ringer, display, and dial pad keys.

NOTE: Performing a self-test of the voice terminal clears the contents of the Call Log and the last number dialed from Redial, and the volume setting is returned to the default.

To make sure your voice terminal is working properly

NOTE: The handset must be on-hook when you test the voice terminal. Performing the self-test terminates any call in progress, and prevents you from receiving calls until the test is completed.

The self-test also clears the Call Log and the last number dialed from Redial, and the volume setting is returned to the default.

- 1 While the handset is on-hook, press **Menu** .
- 2 Press **Next** to see the second Menu screen.
 - The display shows the second Menu screen (shown above).
- 3 Press the softkey below **Test**.
 - The display shows:

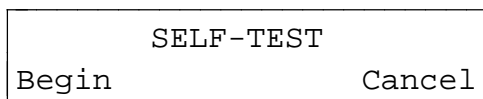

- 4 Press the softkey below **Begin** to start the self-test. (Press the softkey below **Cancel** if you do not want to initiate a self-test of your voice terminal at this time.)
 - When you press **Begin**, the following occurs:
 - The display reminds you to press **Exit** twice if you wish to end the self-test.
 - Terminal emits a tone.
 - Message light goes on.
 - The display shows you the Feature Package number and the Self-Test passed message.

NOTE: If these events do not occur, contact your system manager.
- 5 After you hear repeated tone, press any button on the voice terminal.
 - Terminal emits a key click.
- 6 Press **Mute** , **Speaker** , **Conf** , and **Transfer** .
 - Lights to the left of the **Mute**, **Speaker**, **Conf**, and **Transfer** buttons go on steadily.
- 7 Press **Redial** , **Exit** , **Drop** , and **Hold** .
 - Lights to the left of the **Mute**, **Speaker**, **Conf**, and **Transfer** buttons flutter.
- 8 Pick up handset and press each dial pad key.
 - Message light flutters.
 - Handset emits a touch tone as each key is pressed.
- 9 Hang up handset.
- 10 When the self-test is completed, press **Exit** twice.

NOTE: If you do *not* press **Exit** twice to end the test, the voice terminal automatically exits the self-test after 30 seconds.

Tones and Their Meanings

VOICE TERMINAL TONES

- **busy signal**—A low-pitched tone repeated 60 times a minute (every second); indicates the number dialed is in use.
- **confirmation tone**—Two rising tones; indicates a feature activation or cancellation has been accepted.
- **dial tone**—A continuous tone; indicates dialing can begin.
- **error tone**—An alternating high and low tone; indicates a dialing error, a denial of the service requested, or a failure to dial within a preset interval (usually 10 seconds) after lifting the handset or dialing the previous digit.
- **local error tone**—A steady low tone; indicates an incorrect button press.
- **reorder tone**—A fast busy signal; indicates a call is blocked.
- **self-test tone**—Periodic tones; indicates that the voice terminal is continuing to perform a self-test.
- **speakerphone reset tones**—A rising set of tones; indicates the speakerphone is adjusting itself to the surrounding room acoustics.

Labeling and Installing the Designation Card and the Telephone Number Card

Inside the front cover of this user's manual are button designation cards on which you can write the telephone number, extension, name, or feature that each call appearance/feature button can access. These designation cards match the call appearance/feature buttons on the voice terminal; that is, the buttons are arranged in four columns. The first column is labeled **a** through **g**; the second column is labeled **h** through **n**; the third column is labeled **o** through **u**; the last column is labeled **v** through **z** and **A** and **B**.

Below the perforated bottom edge of each designation card is a telephone number card on which you can write your telephone number.

At the bottom of each designation and telephone number card is an additional attached section which will make it easier for you to insert these cards in a typewriter or run the cards through a laser printer.

To label and install the designation card and telephone number card

- 1** Tear the button designation card, along with the telephone number card and attached "tail," from the user's manual along the perforated edges.
- 2** Label the button designation card with the appropriate number, extension, name, or feature for each call appearance/feature button. Label the telephone number card with your own telephone number. You can handwrite or type the information on the cards or run the cards through a laser printer.
- 3** Separate the button designation card and telephone number card along the perforated border. You may discard the attached "tail" section.
- 4** Place the button designation card under the plastic card cover on the voice terminal. Place the telephone number card under the telephone number card cover located beneath the handset.

Installation

CONTENTS OF THE 8528T PACKAGE

Before you begin, make sure you have the following parts in the box:

- 8528T voice/data terminal (with attached desktop stand)
- K-type handset
- 9-foot handset cord
- 7-foot line cord
- Designation card(s)
NOTE: You will find designation cards at the front of this book.
- Cover(s) for Designation card(s)
- This user's manual

CONNECTING THE 8528T TO THE SYSTEM

The circuitry of the 8528T voice terminal contains a set of terminating resistor jumpers, labeled **ON** and **OFF**. **ON** enables the terminating resistor, and **OFF** bypasses the terminating resistor. It also contains a set of power jumpers, labeled **AUX** (auxiliary), and **PHAN** (phantom). Auxiliary draws power from an adjunct/bulk power unit, and phantom draws power from the PBX.

NOTE: When the voice terminal is shipped from the factory, the terminating resistor jumpers are set to **OFF**, and the power jumpers are set to **AUX**.

The diagram imprinted in the base of the voice terminal, to the right of the jumper pins, shows the location of the power and terminating resistor jumpers. (There are 12 jumper pins, positioned four across and three down. Each of the four jumper posts covers two pins.)

The following paragraphs contain instructions for connecting the 8528T to the system using one of the configurations listed below:

- When the 8528 is connected to a PBX
- When the 8528 is connected to a 5ESS Central Office switch

When the 8528 Is connected to a PBX:

- 1 Locate the terminating resistor jumpers by sliding the cover downward (covering the line jack and adjunct jack) until the power and terminating resistor jumpers are visible. Verify the jumper settings for your given configuration. (See **Figure 5** for these settings.)



WARNING: If any of the jumpers are not set correctly, they must be set by a qualified technician.

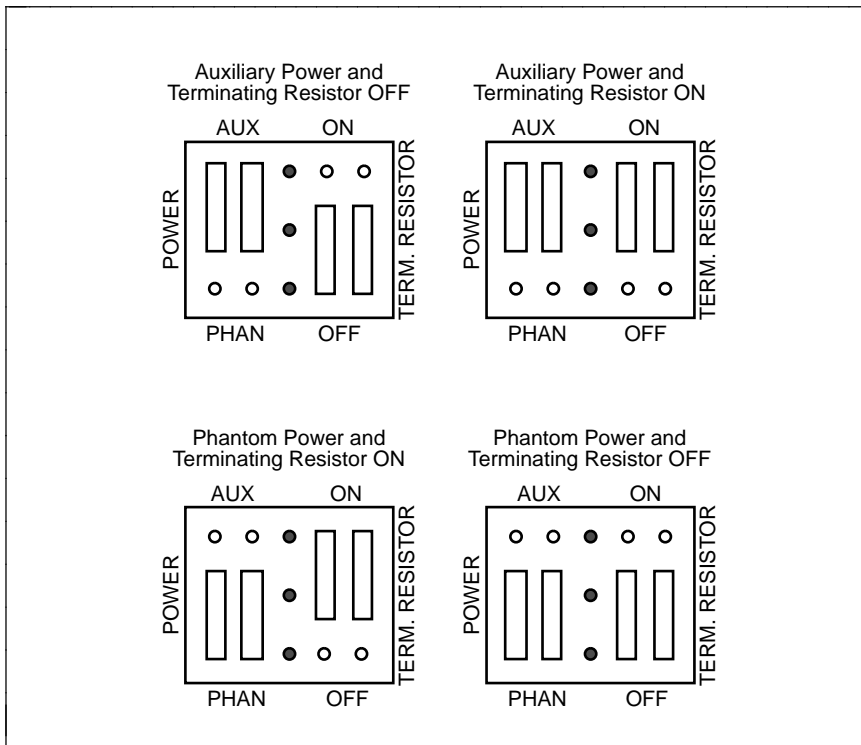

FIGURE 5 Settings for Connection with a PBX

- Verify that the terminating resistor jumpers are set to **OFF**, when the voice terminal is in a point-to-point configuration and the terminating resistor is placed in the closet or a 440A4 is connected on the line.

- Verify that the terminating resistor jumpers are set to **ON**, when the voice terminal is in a point-to-point configuration and the terminating resistor is *not* in the closet or a 440A4 is *not* connected on the line.
 - Verify that the terminating resistor jumpers are set to **OFF**, when the voice terminal is in a multipoint configuration and the terminating resistor is either in the closet, a 440A4 is connected on the line, or the jumper is set to **ON** in any of the other voice terminals on the line.
NOTE: Only one terminating resistor is used for multipoint configuration.
 - Verify that the terminating resistor jumpers are set to **ON**, when the voice terminal is in a multipoint configuration and the terminating resistor is *not* in the closet, or a 440A4 is *not* connected on the line, or the jumper is *not* set to **ON** in any of the other voice terminals on the line.
- 2 Locate the Phantom/Auxiliary power jumpers. Verify the power jumper settings for your given configuration.



WARNING: If any of the jumpers are not set correctly, they must be set by a qualified technician.

- Verify that the power jumpers are set to **PHAN** (phantom) when power is provided by the PBX.
 - Verify that the power jumpers are set to **AUX** (auxiliary) when power is provided in the closet or locally.
- 3 Slide the cover upward (covering the power and terminating resistor jumpers) until the line jack and adjunct jack are visible.

When the 8528 Is connected to a 5ESS Central Office switch:

- 1 Locate the terminating resistor jumpers by sliding the cover downward (covering the line jack and adjunct jack) until the power and terminating resistor jumpers are visible. Verify the jumper settings for your given configuration. (See **Figure 6** for these settings.)



WARNING: If any of the jumpers are not set correctly, they must be set by a qualified technician.

- Verify that the terminating resistor jumpers are set to **OFF**, when the set is in a point-to-point configuration and the terminating resistor is in the closet or a 440A4 is connected on the line.
- Verify that the terminating resistor jumpers are set to **ON**, when the set is in a point-to-point configuration and the terminating resistor is *not* in the closet or a 440A4 is *not* connected to the line.
- Verify that the terminating resistor jumpers are set to **OFF**, when the set is in a multipoint configuration and the terminating resistor is either in the closet or a 440A4 is connected on the line, or the jumper is set to **ON** in one of the other sets on the line. **NOTE:** Only one terminating resistor is used for multipoint configuration.
- Verify that the terminating resistor jumpers are set to **ON**, when the set is in a multipoint configuration and the terminating resistor is *not* in the closet, a 440A4 is *not* connected on the line or, the jumper is *not* set to **ON** in any of the other sets on the line.

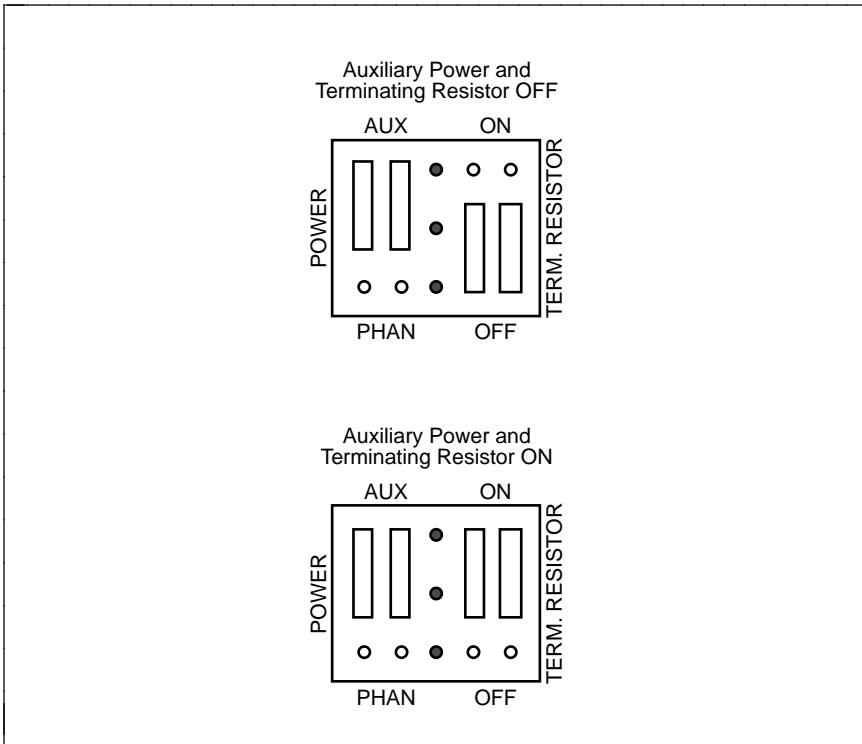

FIGURE 6 Settings for Connection with a 5ESS Central Office Switch

- 2 Locate the Phantom/Auxiliary power jumpers. Verify the power jumper settings for your given configuration.



WARNING: If any of the jumpers are not set correctly, they must be set by a qualified technician.

- Verify that the power jumpers are set to **AUX** (auxiliary).
- 3 Slide the cover upward (covering the power and terminating resistor jumpers) until the line jack and adjunct jack are visible.

DESKTOP INSTALLATION

NOTE: The following instructions describe the installation of the 8528T voice/data terminal on a desk or table.

Use the following directions to connect the line cord and adjunct cord to the appropriate jacks on the voice/data terminal.

- 1 Place the voice/data terminal face down on a flat surface.
- 2 Snap one end of the 7-foot line cord into the “LINE” jack and the adjunct cord (if applicable) into the “ADJUNCT” jack on the bottom of the voice/data terminal. Thread each cord through the routing channel, making sure the cord fits under the square tabs. See **Figure 7** for the location of the jacks. For more information on installing adjuncts, refer to the section “Attaching Adjunct Equipment.”

WARNING: Correct cord types must be used when connecting terminals and associated components. Failure to use the correct cord and/or to properly insert the cord into the jack may cause voice/data terminal malfunction or equipment damage.

- 3 Snap one end of the coiled cord into the Handset jack (marked with the handset symbol) on the bottom of the voice/data terminal, as shown in **Figure 7**. Thread the handset cord through the handset cord routing channel.

WARNING: Do *not* insert the handset cord into the “ADJUNCT” jack. It will cause equipment damage.

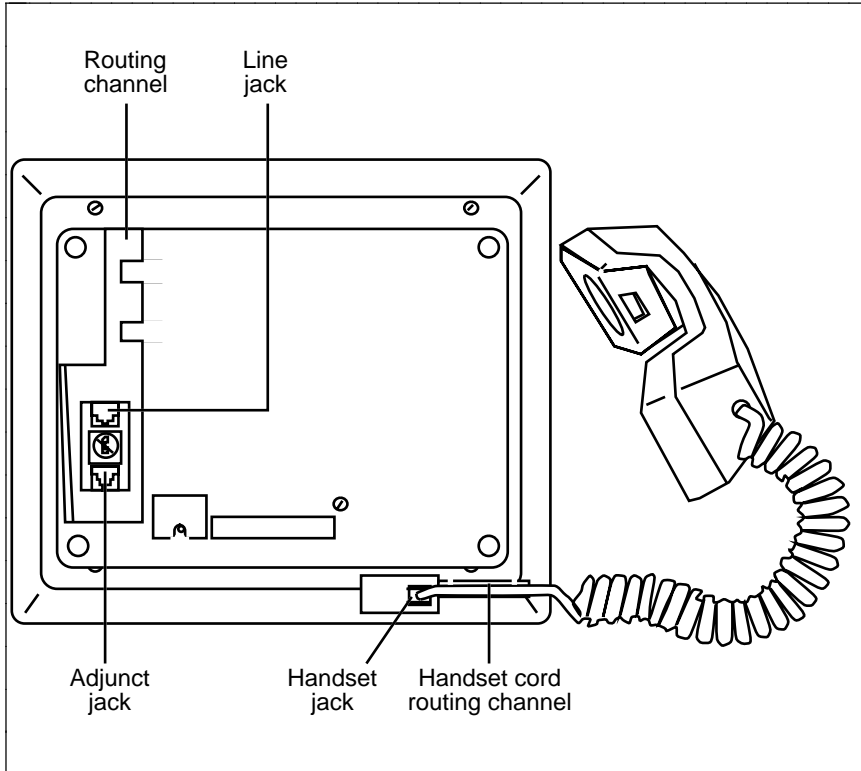

FIGURE 7 Line, Adjunct, and Handset Cord Routing for Desktop Installation

- 4 Turn the voice/data terminal right side up, with the front facing you.
- 5 Snap the free end of the handset cord into the handset and place the handset in the cradle.
- 6 Snap the free end of the line cord into the modular jack. Lift the handset and listen for the dial tone.

ATTACHING ADJUNCT EQUIPMENT

If you are installing a speakerphone (models Lucent S101A, S201A, or QUORUM® CS201A), a headset adapter (model Lucent 500A or the 507A adapter), or other adjunct that may be offered, follow these steps to connect the adjunct equipment to your voice/data terminal.

- 1 Place the voice/data terminal face down on a flat surface.
- 2 Insert the adjunct cord into the “ADJUNCT” jack until you hear a click. See **Figure 7** for the location of the “ADJUNCT” jack.
- 3 Route the adjunct cord through the channel. Refer to the “Desktop Installation” section for instructions.
- 4 Connect the free end of the adjunct cord to your speakerphone or headset adapter.

NOTE: Refer to the adjunct’s installation documentation for its power requirements.

Technical Description

Physical Dimension and Weight

The desktop-mounted voice terminal measures

- 11 3/4 inches (29.8 cm) wide
- 10 3/8 inches (26.4 cm) long
- 5 1/2 inches (14.1 cm) high (with handset)
- 3 1/2 lbs (1.57 kg)

Power Requirements

The 8528T voice terminal requires phantom power or auxiliary power; either is selected by setting a pair of jumpers. If phantom power is used, less than 1 Watt of power is drawn from the switch to support a normal operating mode. If adjunct equipment is connected to the voice terminal, auxiliary power must be used.

WARNING: If auxiliary power is selected, use only a nominal 40 or 48 Vdc, UL-Listed Communications Circuit Power source.

Environmental Requirements

The 8528T can operate in temperatures ranging from 40 to 120 degrees F (4 to 48 degrees C) and relative humidity ranging from 5 to 95 percent.

Index

A

- Adding numbers and names
 - into the Directory, 26
- Adjunct equipment
 - attaching, 80
- Adjunct jack
 - connection, 78, 79, 80
 - description, 7
 - location, 79
- Adjusting the volume
 - receive, 11
 - speaker/speakerphone, 11, 15, 16
 - tone ringer, 63
- Answering calls, 11

B

- Buttons
 - call appearance, 5
 - Conference, 5
 - dial pad, 5
 - display control, 5
 - Dir, 5, 9, 20
 - Exit, 5, 19
 - Menu, 5, 19
 - Next >, 5, 20
 - < Prev, 5, 20
 - Drop, 5
 - Exit, 5, 9
 - Hold, 6
 - Mute, 6
 - Redial, 6
 - Speaker, 6
 - Transfer, 6
 - Volume control, 6

C

- Call Log, 9, 36
 - adding automatically
 - to your Directory, 44
 - calling back callers, 42
 - indication of new
 - unanswered calls, 40
 - locking, 54
 - setting, 36
 - all calls, 40
 - turning on or off, 39
 - unanswered calls only, 40
 - turning on or off, 39

- unlocking, 56
- viewing calls
 - answered incoming, 49
 - outgoing, 51
 - unanswered incoming, 37, 47
- Calls
 - answering, 11
 - Conference, 12
 - Drop, 12
 - ending, 11
 - Hold, 13
 - message retrieval of, 13
 - Mute, 14
 - placing
 - from dial pad, 11
 - from Dir button, 35
 - from Directory softkey, 33
 - Redial, 14
 - speakerphone, 15
 - Transfer, 17
- Changing the password, 58
- Clock, 9
 - setting the, 22
- Conference, 8, 12
- Contrast, 9
- Contrast display level
 - setting the, 60
- Creating the password, 55, 59

D

- Deleting an entry in the Directory, 31
- Designation card, 5
 - installing, 72
 - labeling, 72
- Dial pad, 5
- Dir button, 9, 20, 35
- Directory, 9
 - adding, 26
 - calling, 33, 35
 - deleting, 31
 - editing, 29
 - locking, 54
 - number of names on page, 10, 68
 - unlocking, 56
 - viewing, 33
- Display
 - contrast level
 - setting the, 60
 - control buttons, 5, 18, 20

- messages, 19
- Done
 - responding to, 20
- Drop, 8, 12

E

- Editing the Directory, 29
- Entering a number and name in the Directory, 26
- Entering Softkey Mode, 19
- Exit button, 9, 19
- Exiting Softkey Mode, 19

F

- Feature descriptions
 - display, 9
 - Self-Test, 70
 - softkeys, 9
 - voice, 8
- Features accessed with the display and softkeys, 9, 18
- Flowchart of softkey display screens, 20

H

- Handset, 6
- Handset jack
 - connection, 78, 79
 - description, 7
 - location, 79
- Hold, 8, 13

I

- Information tones
 - turning on or off, 66
- Installing
 - adjunct equipment, 80
 - designation card, 72
 - handset cord, 78
 - line cord, 78
 - telephone number card, 72

L

- Labeling the designation card, 72
- Labeling the telephone number card, 72
- Line jack
 - connection, 78, 79

- description, 7
- location, 79
- Lock feature, 10
- Locking
 - Call Log, 54
 - Directory, 54
 - Softkeys, 54

M

- Menu button, 19
- Message light, 6
- Messages
 - retrieving, 8, 13
 - setting display rate of screens, 64
- Mute, 8, 14, 16

N

- Next button, 20
- Number and name into Directory
 - adding, 26
 - deleting, 31
 - editing, 29
 - entering, 26

P

- Password
 - changing, 58
 - creating, 55, 59
 - removing, 58
- Personalized Ring, 10
 - selecting, 62
- Placing calls
 - from dial pad, 11
 - from Directory
 - using Dir button, 35
 - using the softkeys, 33
- Prev button, 20

Q

- Quit
 - responding to, 20

R

- Rate
 - setting viewing time of display messages, 64
- Redial (Last Number Dialed), 8, 14
- Removing the password, 58

Ring
selecting a personalized pattern, 62
Ringer
adjusting the volume, 63

S

Screen Timing, 10
Selecting a personalized ring, 62
Self-Test, 10, 70
Set Speakerphone, 10
Setting
Call Log, 36, 39
clock, 22
display contrast level, 60
information tones, 66
message display rate, 64
number of names on
Directory page, 68
ringing pattern, 62
speakerphone, 24
Setting the Call Log, 36
all calls, 40
turning of or off, 39
unanswered calls only, 40
Softkeys
Call Log, 36
clock, 22
contrast, 60
description of, 6, 18
Directory, 26
done, 20
enter, 19
exit, 19
flowchart, 20
information tones, 66
locking, 54
number of names on
Directory page, 68
personalized ring, 62
quit, 20
Self-Test feature, 70
speakerphone, 24
unlocking, 56
Softkeys display screens flowchart, 20
Speaker, 8, 15
adjusting the volume, 11, 15
Speakerphone, 8, 15, 24
adjusting the volume, 11, 16
setting, 24

T

Technical description, 81
Telephone number card, 6
installing, 72
labeling, 72
Tone ringer
adjusting the volume, 63
Tones, 10
description, 71
setting, 66
Transfer, 9, 17

U

Unlocking
Call Log, 56
Directory, 56
Softkeys, 56

V

Viewing
Call Log
answered incoming, 49
outgoing, 51
unanswered incoming, 37, 47
Directory entry, 33
Voice Features, 11